

# COMFORT

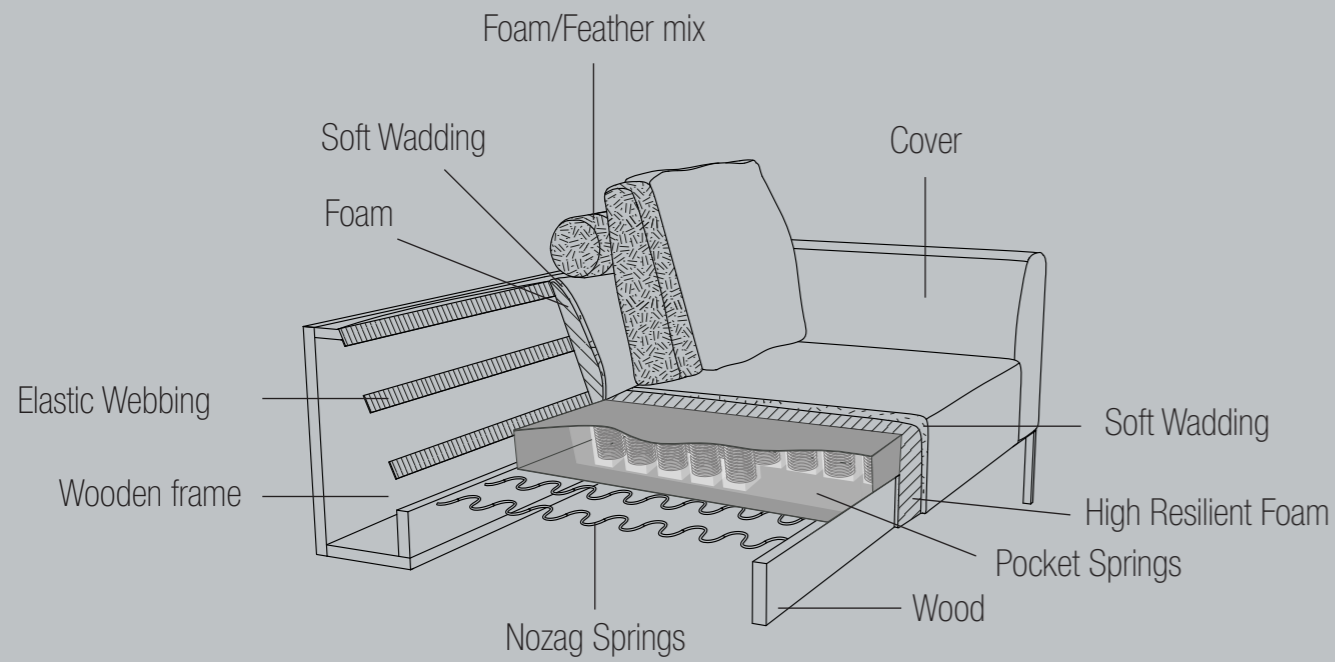

# DIMENSIONS

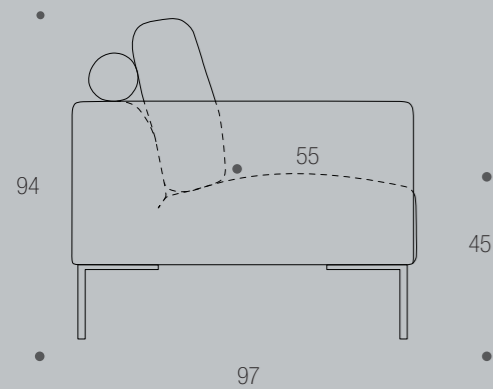

# DESIGN ELEMENTS

20 Modules  
Available in fabric and leather

# HOW TO DESIGN

1. Choose design 154
2. Choose combination
3. Choose fabric or leather
4. Choose legs

# LEGS



# SAVA



Sava is an exclusive modular stand-alone sofa system, that is designed with perfect proportions and superior comfort in mind. The modular system gives you endless opportunities for combinations of your choice.

# COMBINATIONS

SAVA

3-seater **3221**

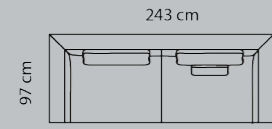

2½-seater **2521**

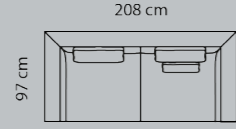

2-seater **2221**

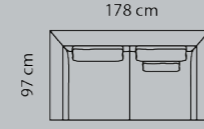

Foot rest **1760**

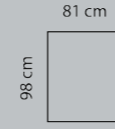

Corner **1620**

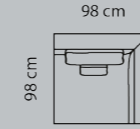

Shown Mirrored Left Right **1410 1405**

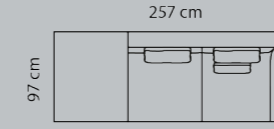

Shown Mirrored Left Right **1430 1425**

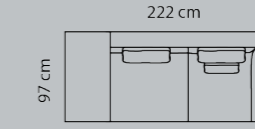

Shown Mirrored Left Right **1810 1805**

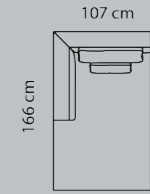

Price group	M3: 1,37 3-seater Metal legs			M3: 1,17 2½-seater Metal legs			M3: 1,01 2-seater Metal legs			M3: 0,25 Foot rest Metal legs			M3: 0,55 Corner Metal legs			M3: 1,44 Open-end Large Metal legs			M3: 1,30 Open-end Small Metal legs			M3: 1,03 Chaiselong Metal legs		
	Brushed	Black	Oak	Brushed	Black	Oak	Brushed	Black	Oak	Brushed	Black	Oak	Brushed	Black	Oak	Brushed	Black	Oak	Brushed	Black	Oak	Brushed	Black	Oak
1	.....																							
2	.....																							
3	.....																							
4	.....																							
5	.....																							
Eton w. Split	.....																							
Eton	.....																							
Savoy w. split	.....																							
Savoy	.....																							
Safari	.....																							
Nature	.....																							
Vintage	.....																							
	Boxes of legs incl.		2	Boxes of legs incl.		2	Boxes of legs incl.		2	Boxes of legs incl.		2	Boxes of legs incl.		2	Boxes of legs incl.		2	Boxes of legs incl.		2	Boxes of legs incl.		2

Shown Mirrored Left Right **3210 3205**

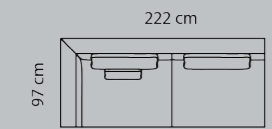

**3220**

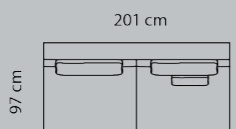

Shown Mirrored Left Right **2510 2505**

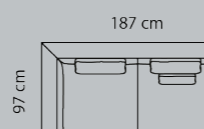

2½-seater - no arms **2520**

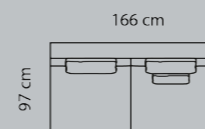

Shown Mirrored Left Right **2210 2205**

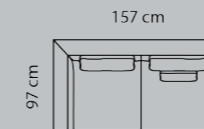

2-seater NO arms **2220**

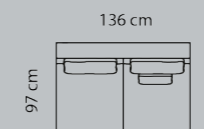

Additional cushions

Large **100 0026**

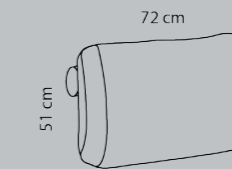

Deco cushions

**100 0024**

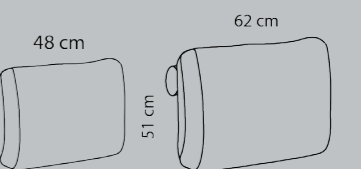

**100 0025**

Price group	M3: 1,25 3-seater with 1 arm Metal legs			M3: 1,13 3-seater - no arms Metal legs			M3: 1,06 2½-seater with 1 arm Metal legs			M3: 0,94 2½-seater - no arms Metal legs			M3: 0,89 2-seater with 1 arm Metal legs			M3: 0,78 2-seater NO arms Metal legs			M3: 0,12 Back cushion for 3-seater			M3: 0,01 Deco cushions		M3: 0,11 Deco cushions	
	Brushed	Black	Oak	Brushed	Black	Oak	Brushed	Black	Oak	Brushed	Black	Oak	Brushed	Black	Oak	Brushed	Black	Oak							
1	.....																								
2	.....																								
3	.....																								
4	.....																								
5	.....																								
Eton w. Split	.....																								
Eton	.....																								
Savoy w. split	.....																								
Savoy	.....																								
Safari	.....																								
Nature	.....																								
Vintage	.....																								
	Boxes of legs incl.		2	Boxes of legs incl.		2	Boxes of legs incl.		2	Boxes of legs incl.		2	Boxes of legs incl.		2	Boxes of legs incl.		2	n.a.: not available						

**Additional connector for foot rest 932000242**

Only for use if foot rest is attached to base modules. Then 2 connectors are needed!

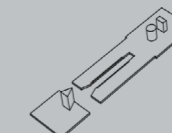

Connectors are otherwise included in base modules

**Remember to choose legs!**

The last 3 digits in the item no. determines the thype of legs

**Oiled oak 003**  
**Brushed metal 020**  
**Black metal 040**

Ex.: 3-seater with black metal legs: 1543221xxxx040

SAVA	Module	Fabric	Legs
154	3221	xxxx	040

All measurements are approximate. Please allow for a tolerance of +/- 3 cm.